

Fravol

woodworking machines

MASTER

M series



fravol.it

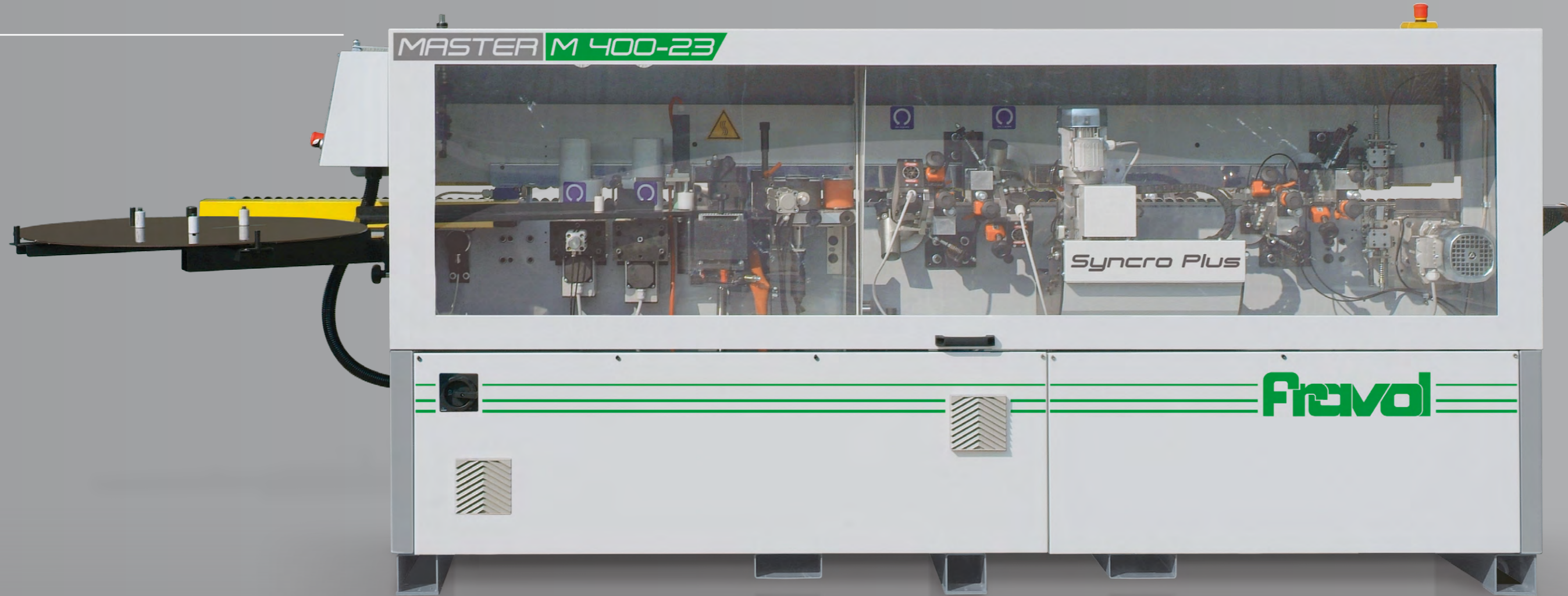

style & technology

inside



IT Macchina Bordatrice

- Macchina Bordatrice automatica per l'applicazione di bordi in PVC, ABS, melaminico, impiallacciatura, masselli, in strisce o rotolo.
- Macchina compatta e robusta.
- Ideale per l'industria e l'artigianato.

- Avanzamento 7 mt/min.

- Rapida nel riscaldamento; la partenza avviene in 6 ÷ 8 minuti.
- Capacità della vasca colla: Kg 1.
- Gruppi regolati automaticamente con barra pressore avente una doppia fila di ruote.

EN Edge-Banding Machine

- Single automatic edging machine for application of PVC, ABS, melamine, veneer and solid wood edges in strips or rolls.
- Compact sturdy machine.
- Ideal for industrial or artisan use.

- Adjustable 7 mt/minutes.
- Quick heating, start-up 6 ÷ 8 minutes.
- Glue pot capacity: Kg. 1.

- The units are adjusted automatically with pressure bar provided with a double row of wheels.

FR Encolleuse de Chants

- Machine Encolleuse automatique pour l'application de chants en PVC, ABS, mélaminé, plaqué, massif, en bande ou rouleau.
- Machine compacte et robuste.
- Idéale pour l'industrie et l'artisanat.

- Avancement 7 mt/min.
- Rapide dans l'échauffement, la partie arrive en 6 ÷ 8 minutes.
- Capacité du bac à colle: 1 Kg.

- Groupes presseurs réglable automatiquement composé de deux rangées de roulettes.

DE Kantenanleimmaschine

- Automatische Kantenanleimmaschine für das Anleimen und Nachbearbeiten von PVC-ABS-Melamin- und Furnierkanten als Streifen- oder Rollenware und Massivholzkanten.
- Kompakte und stabile Maschinenbauweise.
- Der ideale Automat für den Industriebetrieb und die Möbelwerkstätte.
- Vorschubgeschwindigkeit stufenlos bis 7 mt/Min.
- Schnellheizbecken, Aufheizzeit max. 6 ÷ 8 Minuten.
- Leimbeckeninhalt ca. 1 Kg.
- Oberdruckwerk mit doppelter Reihe von Druckrollen, gleichzeitig Höhenverstellung der oberen Nachbearbeitungsaggregate mit dem Oberdruckwerk.

ES Encoladora de Canto

- Máquina automática para el encolado de cantos en PVC, ABS, melamina, madera, en tiras o rollos.
- Máquina compacta y robusta.
- Ideal para la industria y el pequeño taller.

- Avance 7 mt/min.
- Calentamiento rápido de 6 ÷ 8 minutos.
- Capacidad del depósito de cola: 1 Kgs.

- Grupos regulados automáticamente con barra prensora con doble fila de ruedas.

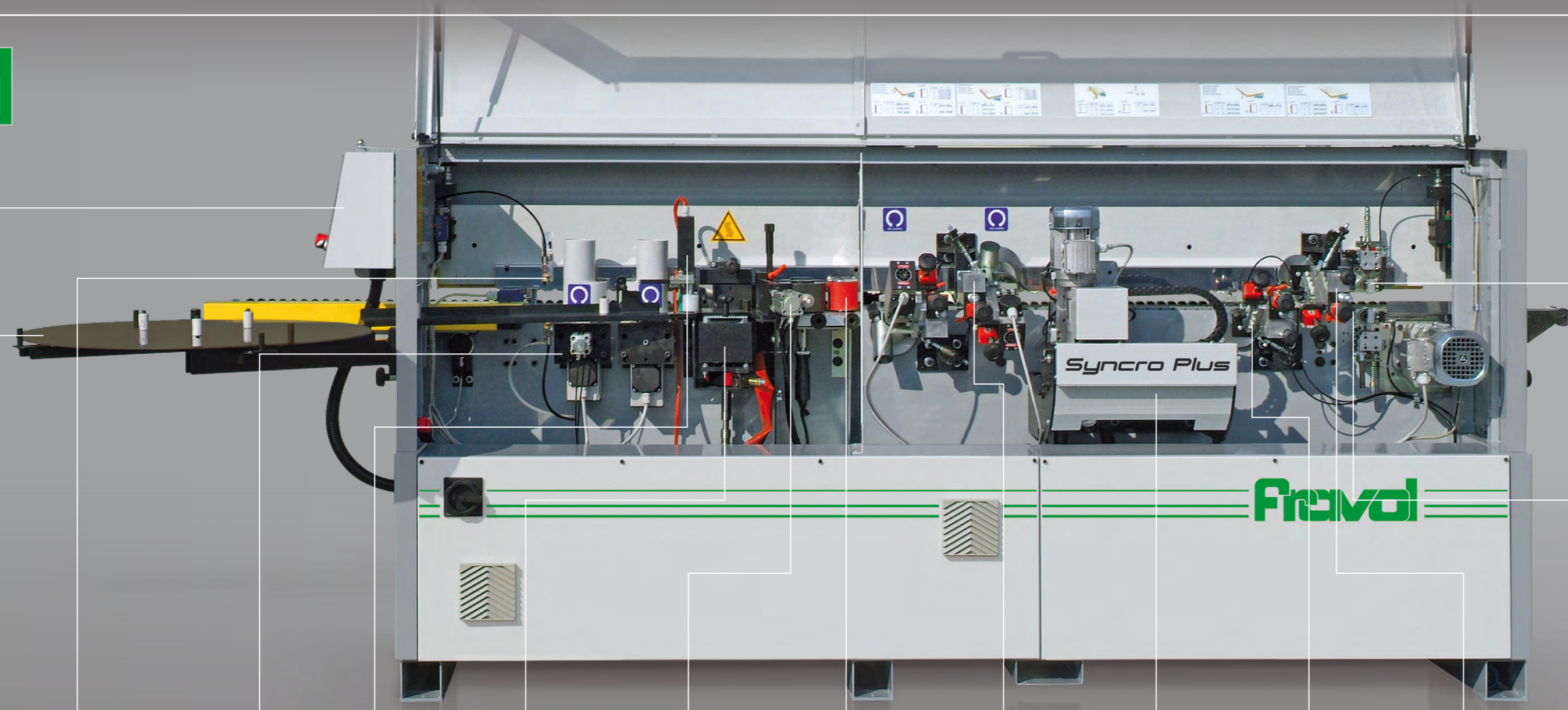

configuration

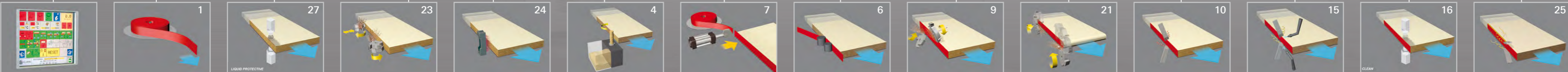



M200-23

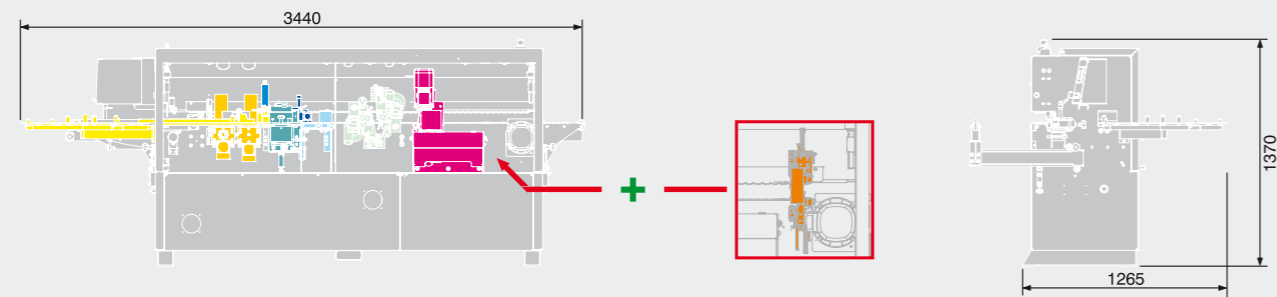

M400-23

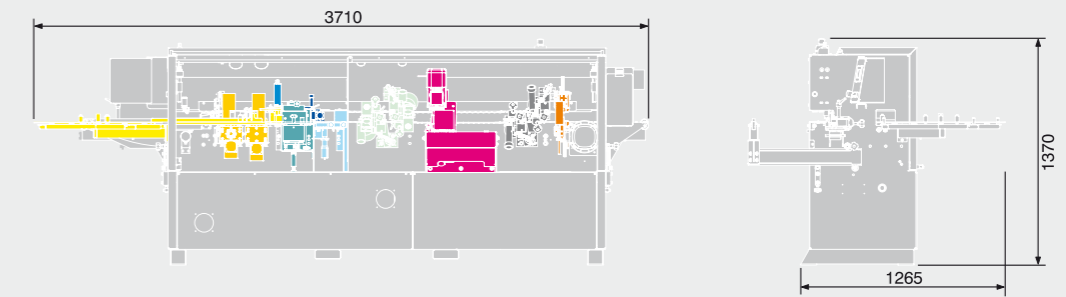

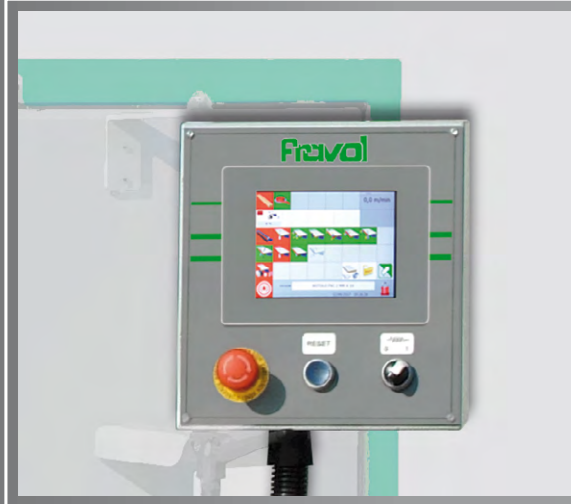

Touch Screen
7" Colour



- IT Controllo con microprocessore (P.L.C.)
- EN Microprocessor control (P.L.C.)
- FR Contrôle avec microprocesseur (P.L.C.)
- DE Mikroprozessor-Steuerung (S.P.S.)
- ES Control con microprocessor (P.L.C.)



27

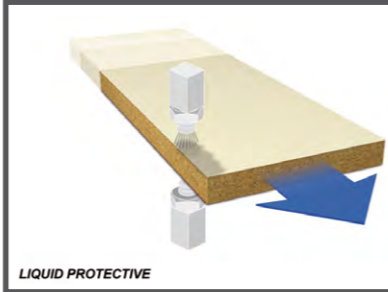

LIQUID PROTECTIVE

- IT Sistema di spruzzatura dell'agente distaccante
- EN Release agent spraying system
- FR Système de pulvérisation d'agent de démoulage
- DE Trennmittel-Sprühsystem
- ES Sistema de spray del agente antiadherente



quick release

30

1,0 Kg

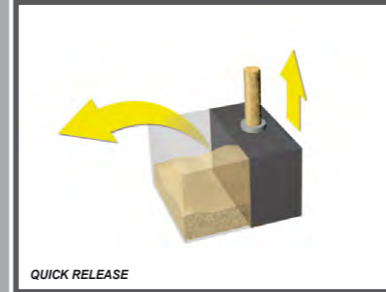

QUICK RELEASE

- IT Vasca colla con sgancio rapido
- EN Glue tank with quick release
- FR Bac a' colle avec system de changement rapid
- DE Leimbecken mit schnellverschluss-system
- ES Calderin de cola con desenganche rapido



14

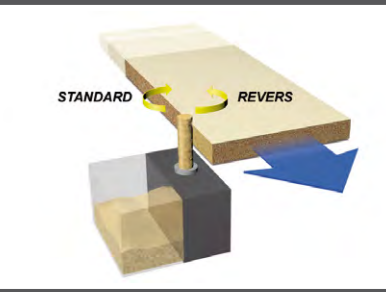

- IT Vasca colla con reverse
- EN Auto-reverse glue tank
- FR Bac a colle auto-reverse
- DE Reverse (Doppel-Rotationsinn)
- ES Deposito cola auto-reverse

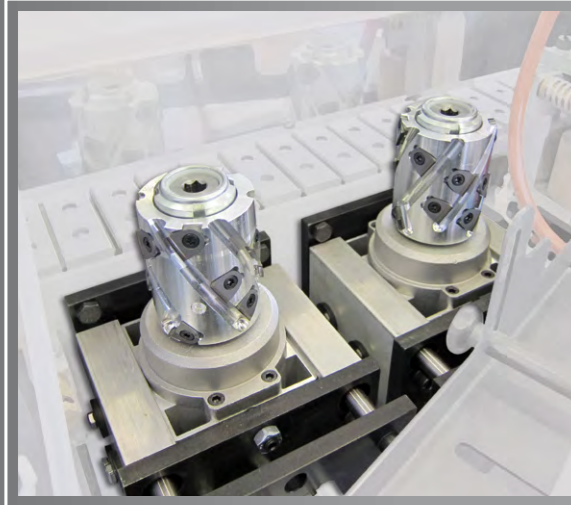

23

0,75+1,1 Kw
12.000 rpm

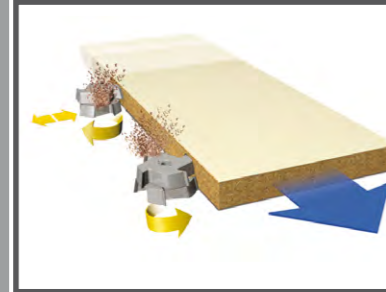

- IT Toupie in entrata
- EN Pre-Milling Unit
- FR Toupie en entrée
- DE Füge-Fräsggregat am Maschinenleinlauf
- ES Toupie en entrada



24

0 - 600°C
250 Watt

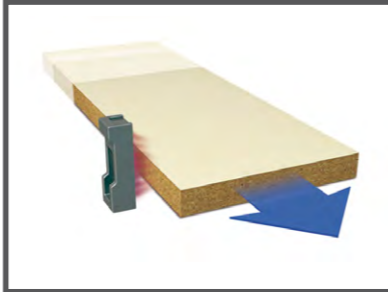

- IT Lampada IR
- EN IR Lamp
- FR Lampe IR
- DE IR Lampe
- ES Lámpara IR

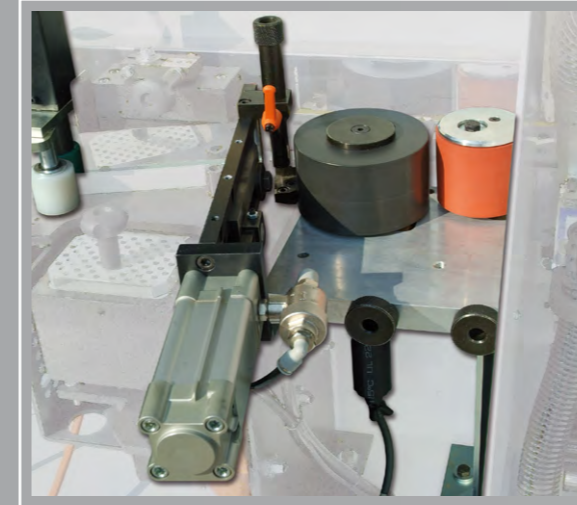

6

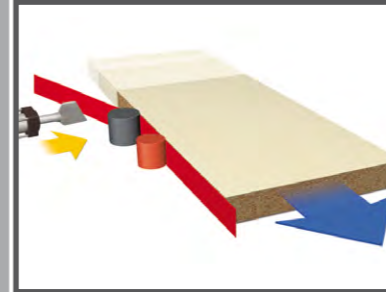

- IT Rulli pressore
- EN Pressure rollers
- FR Rouleau presseur
- DE Andruckrollen
- ES Rodillos de presion

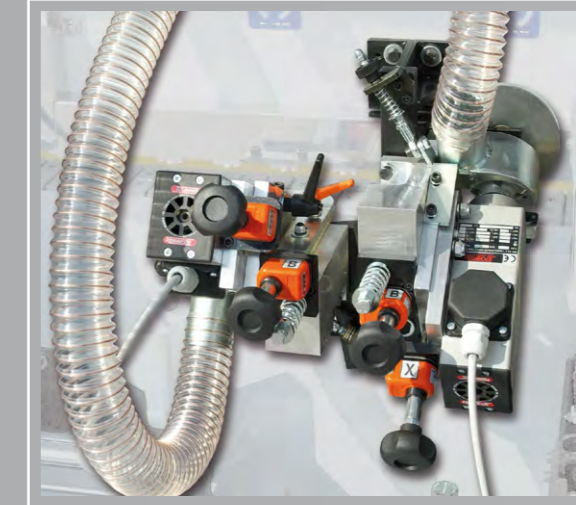

9

0,37 Kw
12.000 rpm

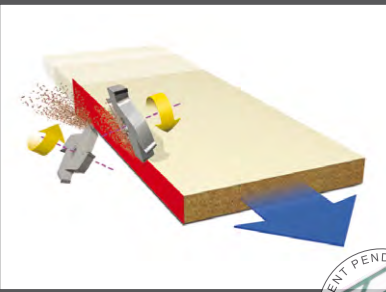

- IT Rifilatore inclinabile
- EN Heavy Duty Bevel Trim Unit
- FR Dégrossés
- DE Vorfräsen (Planfräsen)
- ES Desbastador



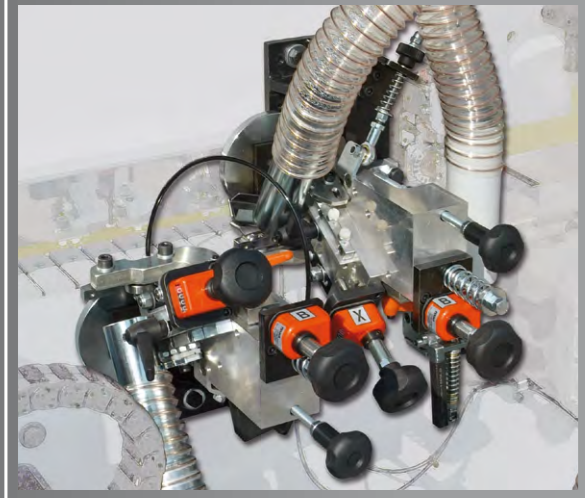

10
 IT Raschiatore
 EN Scraping Unit
 FR Racler
 DE Nachputzen
 ES Rascador

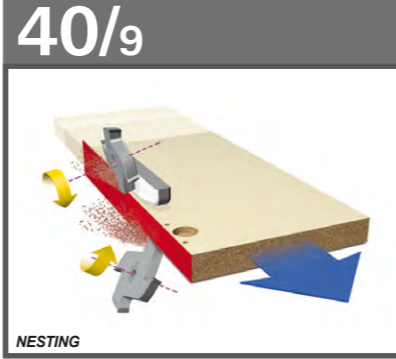

40/9
 NESTING
 IT Copiatori NESTING
 EN Copy NESTING
 FR Copieurs NESTING
 DE Kopierer NESTING
 ES Copiadores NESTING

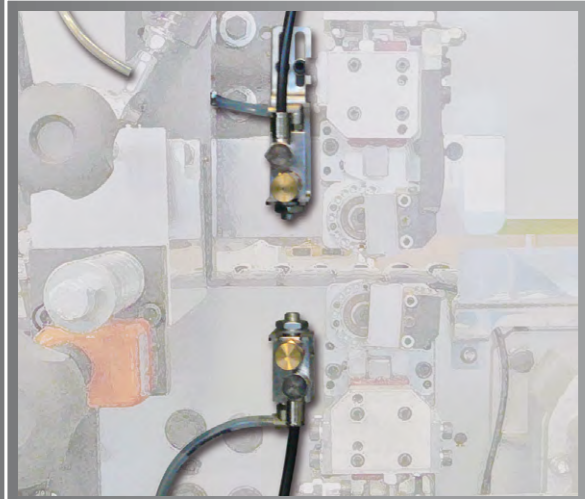

16
 LIQUID CLEAN
 IT Sistema di spruzzatura dell'agente pulente
 EN Cleaning agent spraying system
 FR Dispositif de lubrification nettoyant
 DE Reinigungsmittel-Sprühsystem
 ES Sistema de spray para agente limpiador

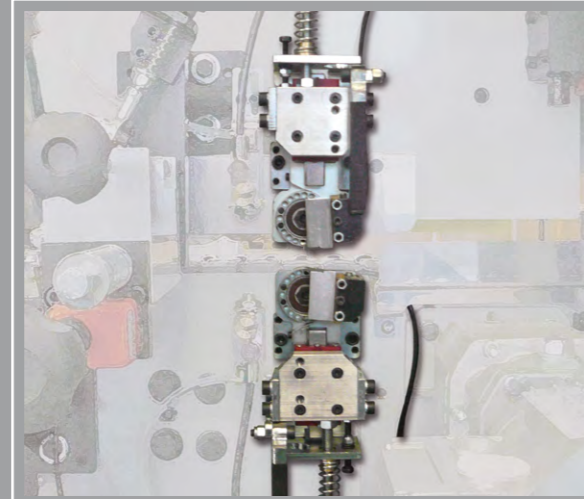

25
 IT Raschia colla
 EN Glue scraper
 FR Groupe racler de colle
 DE Leimziehaggregat
 ES Grupo rascacola

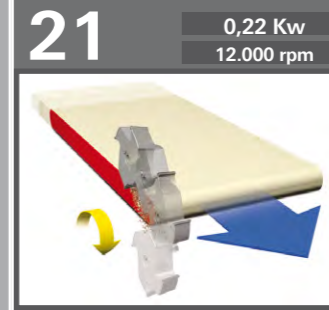

21
 0,22 Kw
 12.000 rpm
 IT Arrotondatore
 EN Corner Rounding Unit
 FR Arrondir l'Angle
 DE Eckenabruundaggregat
 ES Redondeador de ángulo

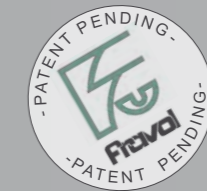
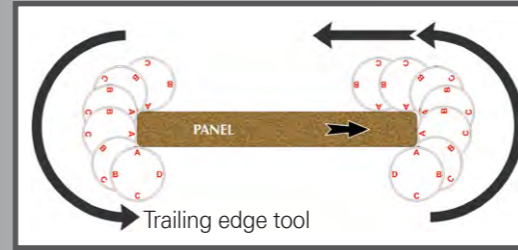

Modello - Model Modèle - Modell - Modelo	M200-23	M400-23
Spessore pannello - Panel thickness Espaisseur panneau - Werkstückdicke Espesor panel	10 ÷ 45 mm 60 mm with opt. 15	10 ÷ 45 mm 60 mm with opt. 15
Larghezza pannello - Panel width Largeur Panneau - Werkstücklänge Largo panel	min. 60 mm	min. 60 mm
Larghezza bordo - Edge width Largeur chant - Kantendicke Anchura canto	12 ÷ 48 mm	12 ÷ 48 mm
Spessore bordo - Edge thickness Espaisseur chant - Kantendicke Espesor canto	0,4 ÷ 6,0 mm with syncro unit max. 3,0 mm	0,4 ÷ 6,0 mm with syncro unit max. 3,0 mm
Avanzamento - Feed Avancement - Vorschub - Avance	7,0 m/min (STD)	7,0 m/min (STD)
Voltaggio - Voltage Voltage - Spannung - Voltaje	220/380 V 50/60 Hz - 3 Ph + N	220/380 V 50/60 Hz - 3 Ph + N
Lunghezza pannello - Panel length Longeur panel - Werkstücklänge Largo panel	min. 120 (PVC)	min. 120 (PVC)
Potenza installata - Installed power Puissance installée Leistung installierte	3,2 kw	3,4 kw
Potenza pneumatica - Pneumatic power Puissance pneumatique Leistung pneumatik - Potencia neumatico	6 bar	6 bar
Peso Kg. - Weight Kgs. Poids Kgs. - Gewicht Kgs. - Peso Kgs.	920	1000

Dimensioni di imballo - Wood case dimensions		
A	3500 mm	3800 mm
B	900 mm	900 mm
C	1470 mm	1470 mm

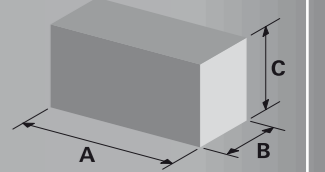

profile tools

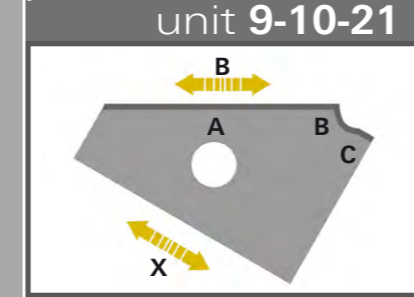

unit 9-10-21
 IT Utensile Rifilatore Raschiatore
 EN Tool fine trimming Scraping unit
 FR Outil affleurage - racler
 DE Vorfräs-Ziehklingenwerkzeug
 ES Herramineta refilador - rascador

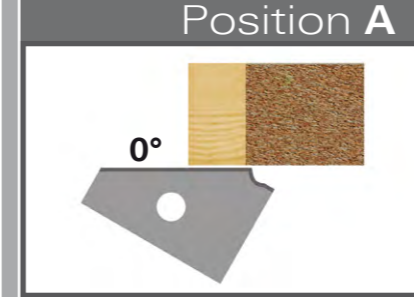

Position A
 IT Profilo piano 0°
 EN Flat profile 0°
 FR Profil plan 0°
 DE Flaches Profil 0°
 ES Perfil plano 0°

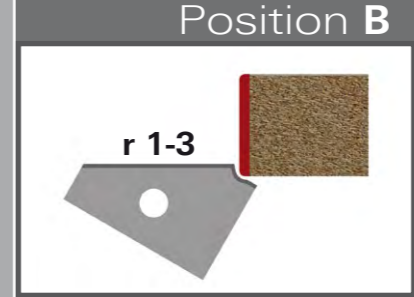

Position B
 IT Raggio profilo da 1,0 a 3,0
 EN Radius profiles from 1,0 to 3,0
 FR Profil rayon de 1,0 à 3,0
 DE Profilradius von 1,0 bis 3,0
 ES Perfil de radio de 1,0 a 3,0

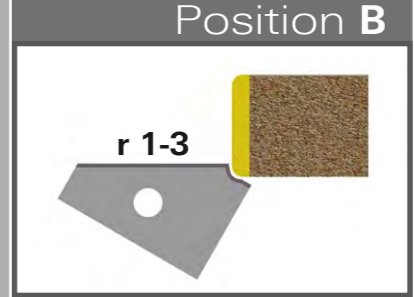

Position B
 IT Raggio profilo da 1,0 a 3,0
 EN Radius profiles from 1,0 to 3,0
 FR Profil rayon de 1,0 à 3,0
 DE Profilradius von 1,0 bis 3,0
 ES Perfil de radio de 1,0 a 3,0

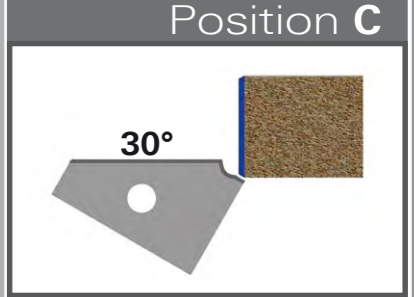

Position C
 IT Profilo inclinato a 30°
 EN Inclined profile 30°
 FR Profil incliné à 30°
 DE Um 30° geneigtes Profil
 ES Perfil inclinado a 30°



Fravol

macchine per la lavorazione del legno
manufacture of woodworking machines

uff. e dep.: via A. Niedda, 6 - 35010
Peraga di Vigonza - (PD) - Italy
tel. +39 - 049 725085 - 725888
fax +39 - 049 8931635
www.fravol.it - fravol@fravol.it